



# Help install the smoke detector.



Smoke detectors  
should be located  
just outside your  
bedrooms and on  
each floor of  
your home.

**START**

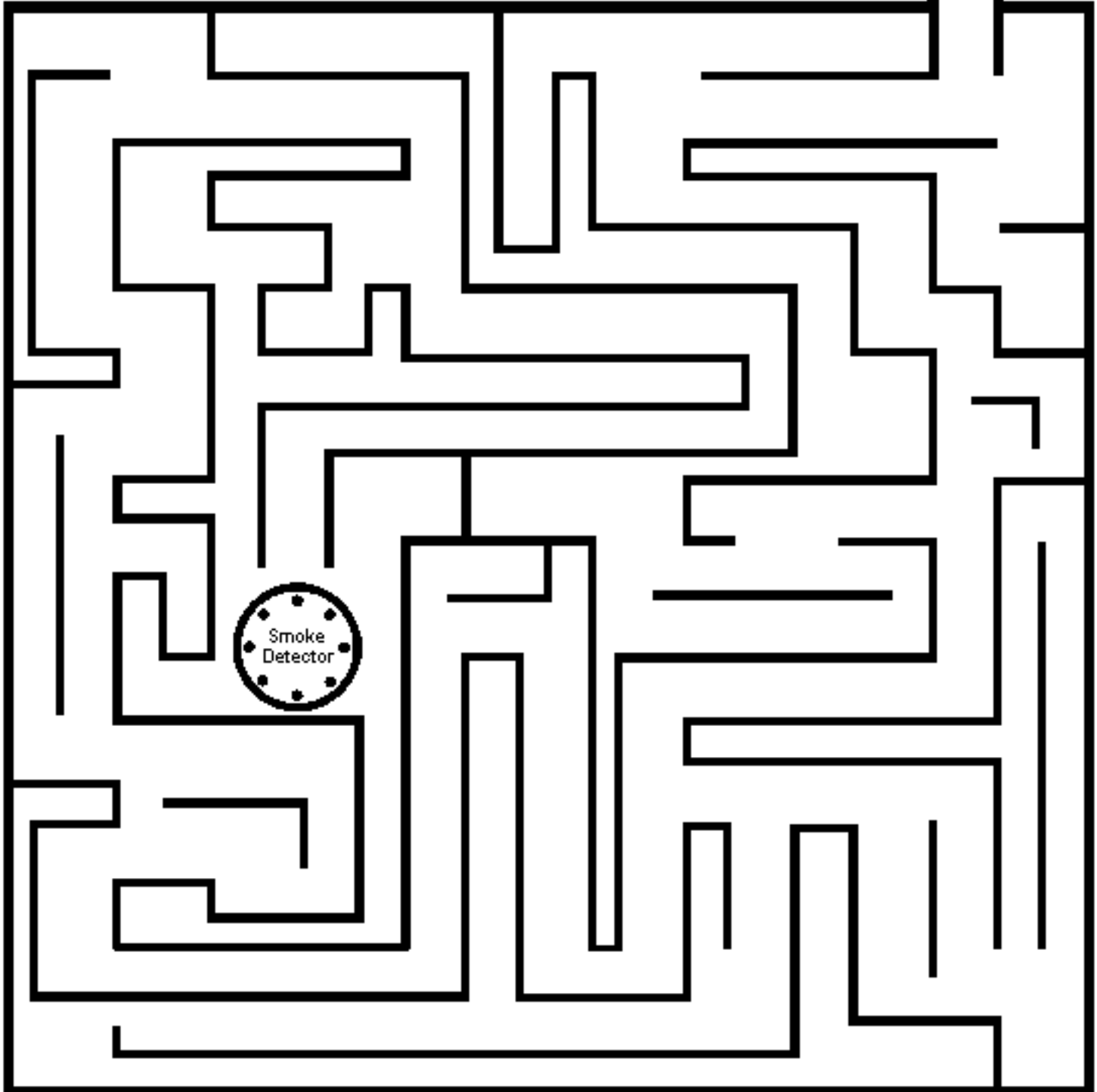

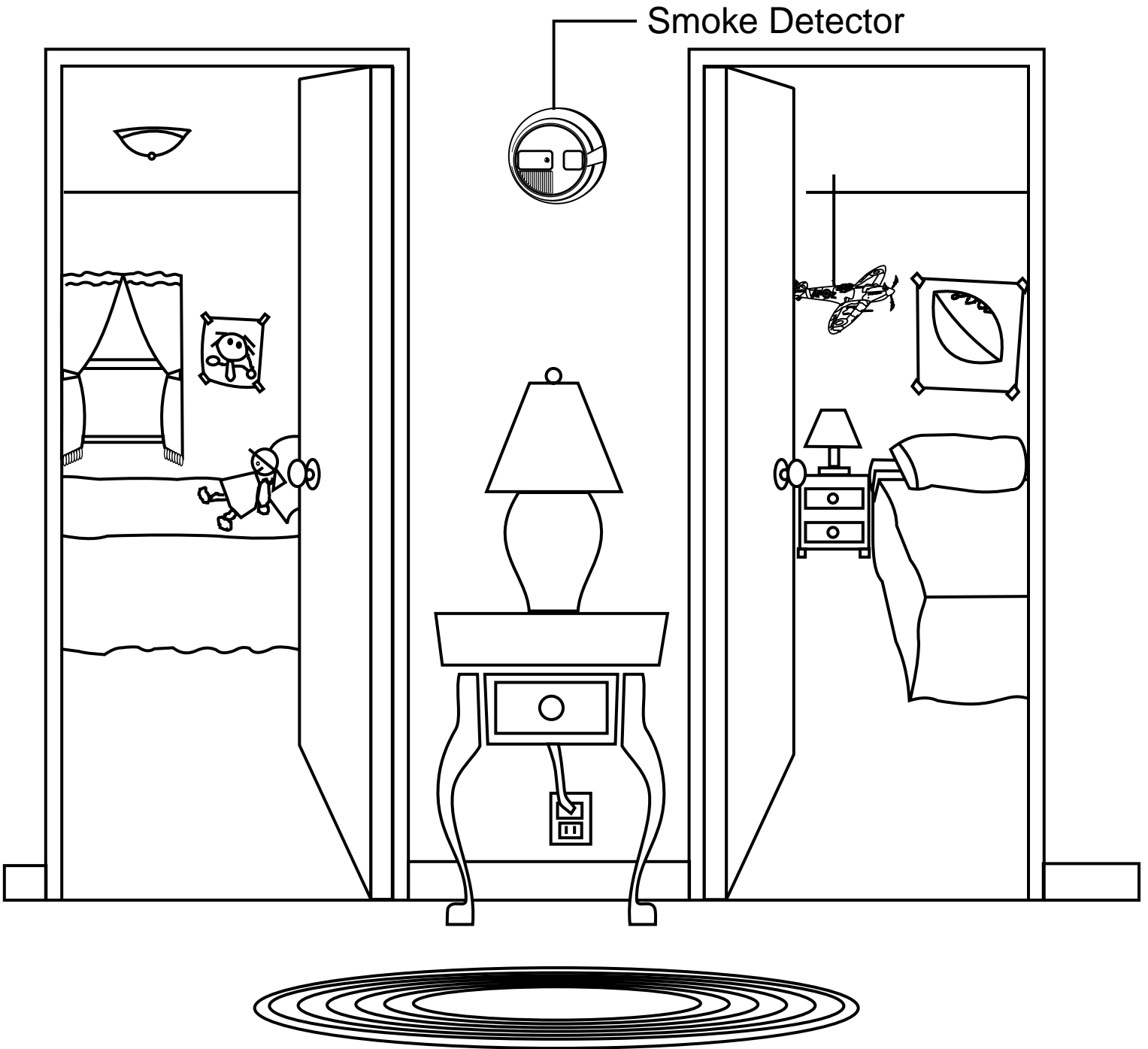

Do you have a smoke detector near where you sleep? Does it work? If not, ask your mom or dad to put up a smoke detector near the bedrooms and make sure it works.

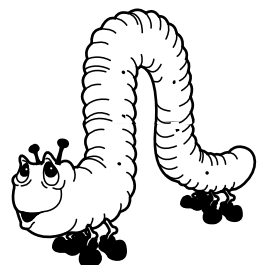

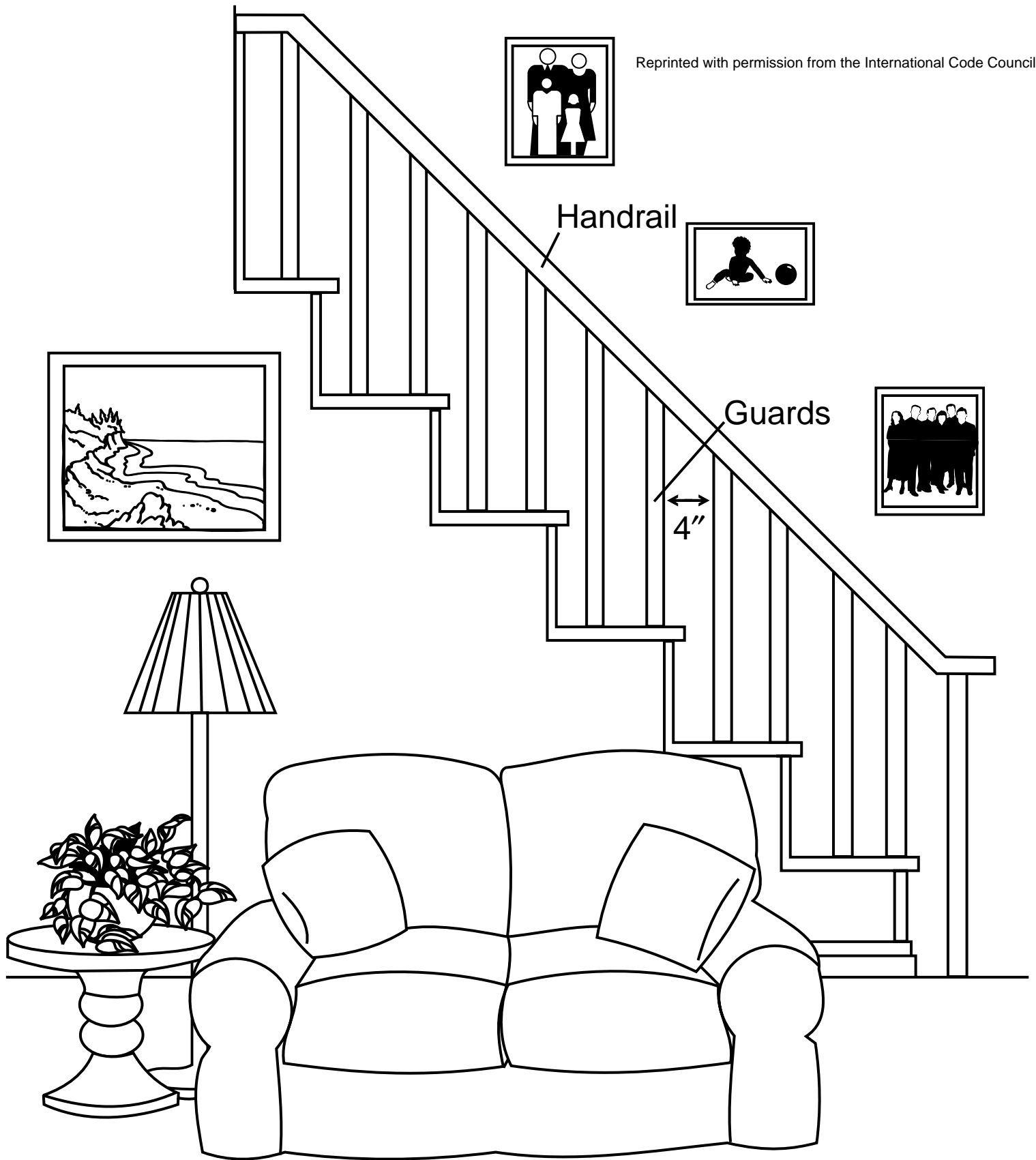

Between the handrail and the steps, are there guards to protect little kids? Is the space between the guards too wide? Kids can get their heads stuck or fall out if the space is wider than 4 inches.

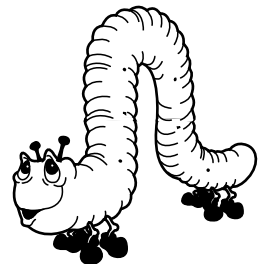

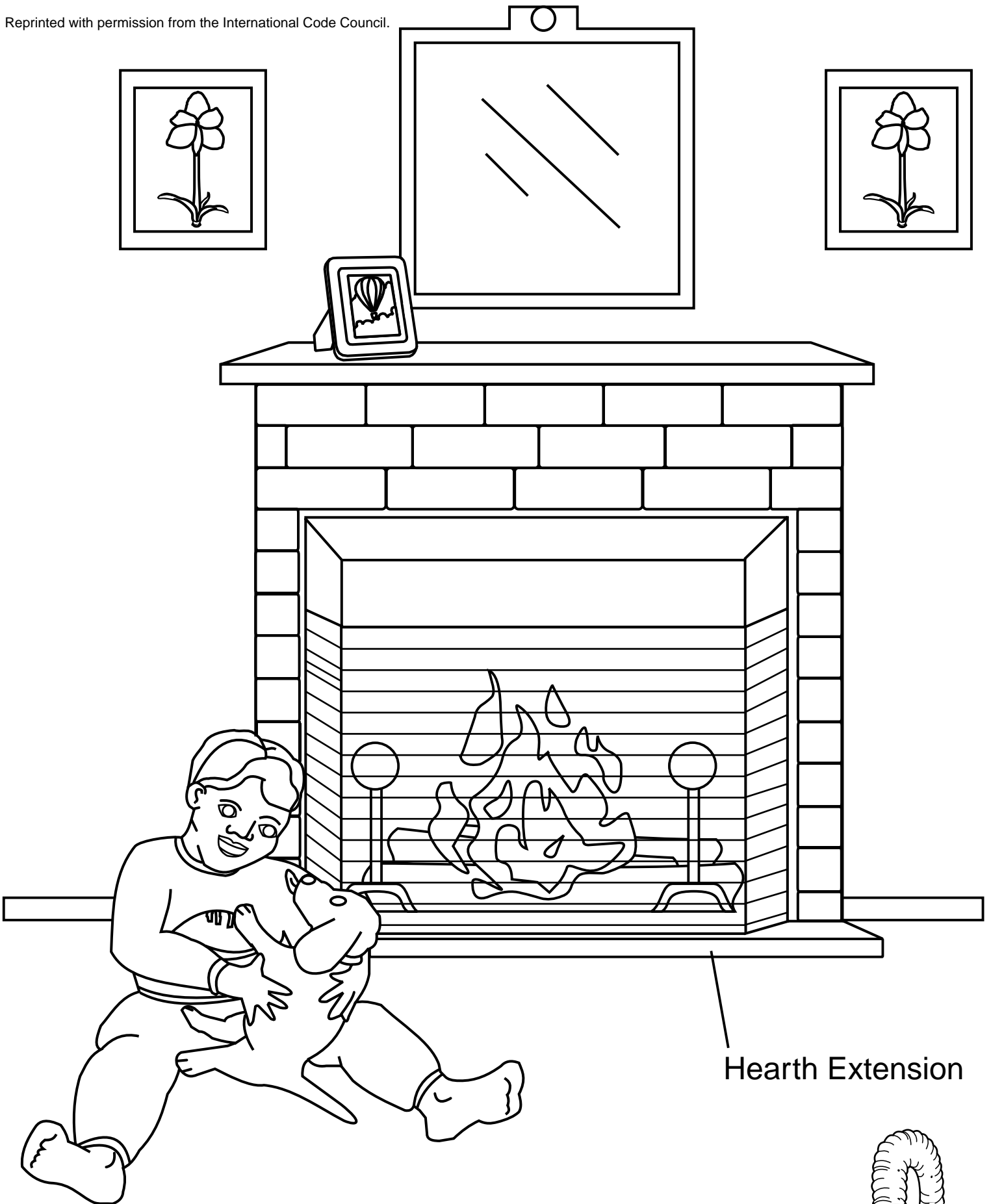

Hearth Extension

Does your fireplace have a hearth extension? (That's the brick or stone slab in front of the fireplace.)

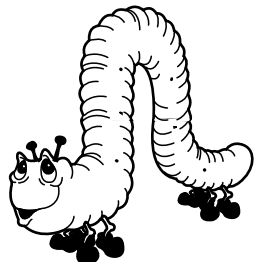

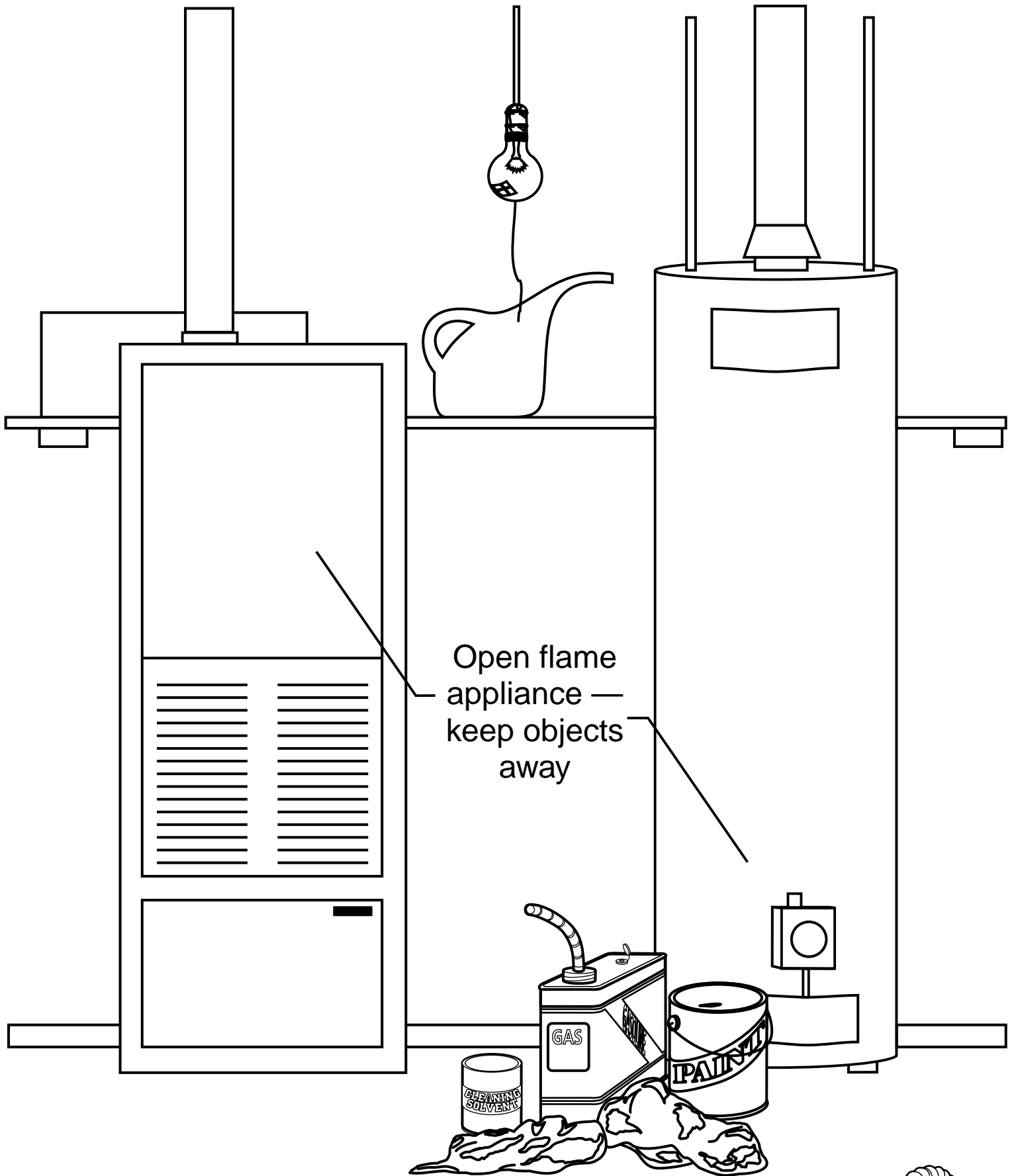

Open flame  
appliance —  
keep objects  
away

Reprinted with permission from the International Code Council.

Tell your mom or dad not to put anything  
near the heater.

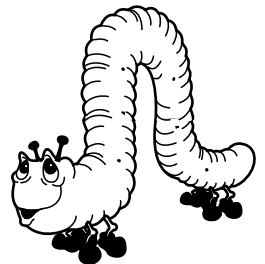

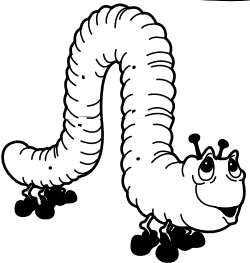

Ask your mom or dad if your bathtub or shower is protected so that the water cannot get too hot.

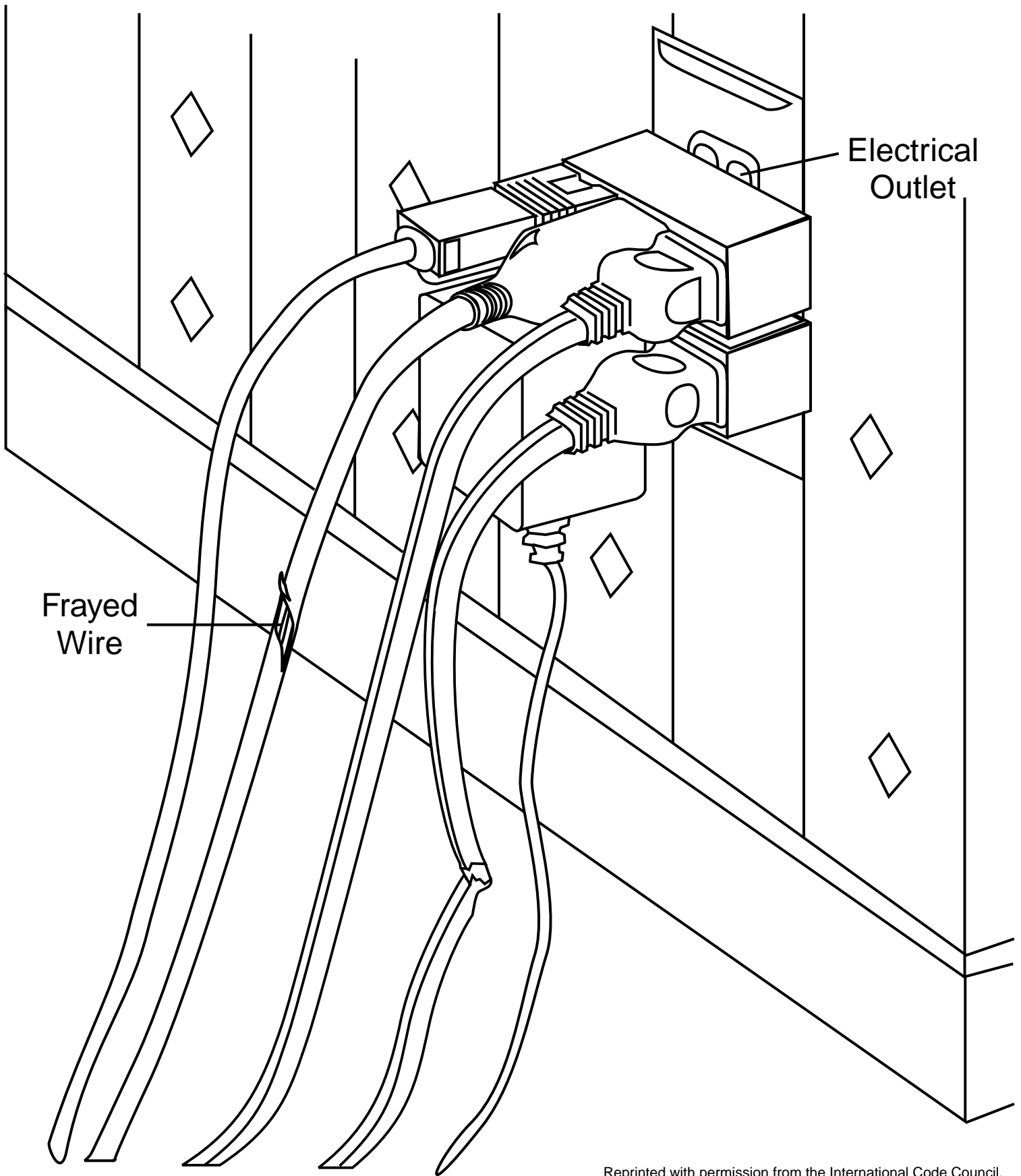

Reprinted with permission from the International Code Council.

Do the electrical outlets in your home have too many cords? Ask your mom or dad to check that the wires are not cracked or frayed.

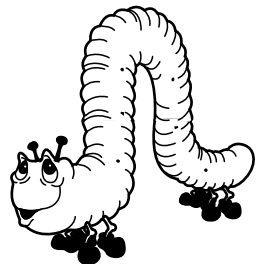



# Escape Plan

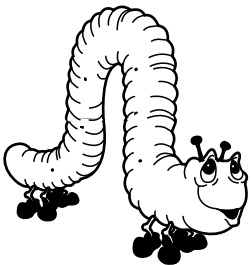
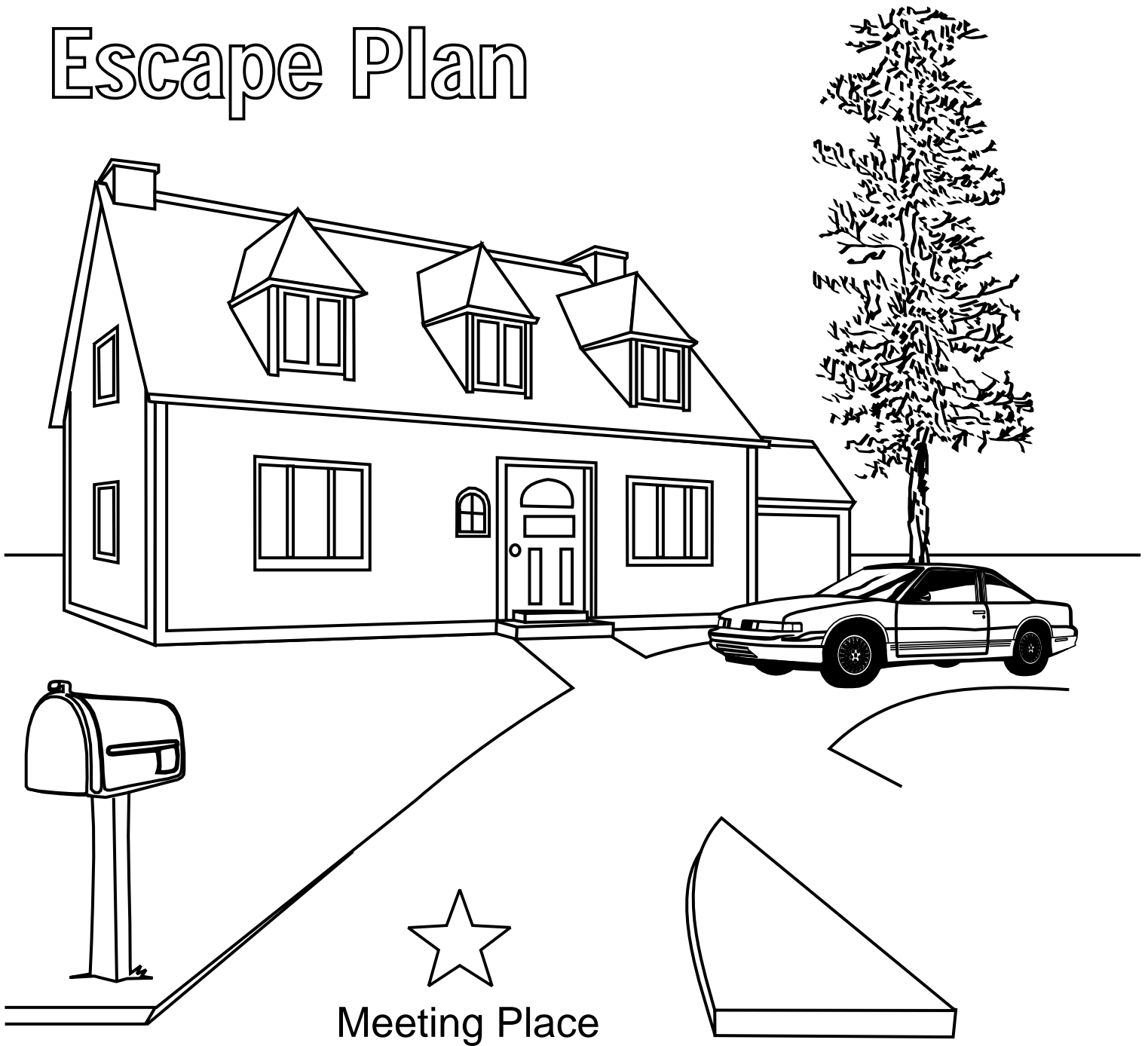

Do you have an escape plan for your home?  
What is the best way to get outside from upstairs?  
Has your family had a fire drill?